



# MEDIA BT3

Wireless Hi-Fi Speakers

EN







## Contents

<b>04</b>	<b>Safety Information</b>
<b>05</b>	<b>Package Contents</b>
05	Introduction
05	Package Contents
<b>06</b>	<b>Features</b>
06	Feature Summary
06	Product Description
<b>07</b>	<b>Instructions</b>
07	Attaching the Feet
08	Features
12	Remote Control
13	Operation
<b>18</b>	<b>Specification</b>
<b>19</b>	<b>Warranty</b>

### EC DECLARATION OF CONFORMITY

Q-BT3 conforms with the following EEC Directives, their supporting Statutory Instruments and relevant Standards, where applicable as follows:

EC Council Directive on electromagnetic compatibility 2004/108/EC,

Applicable standards with amendments:

EN5013:2001 + A1:2003 + A2:2006
EN55020:2007
EN61000-3-2:2006 + A1:2009 + A2:2009
EN61000-3-3:2008

EC Low Voltage Directive 2006/95/EEC,

Applicable standard with amendments:

EN60065:2002 + A1:2006 + A11:2008 + A2:2012
---

Stage 1 of annex II of Commission regulation (ErP) EC no. 1275/2008

## Safety Information

### IMPORTANT INFORMATION - PLEASE READ CAREFULLY



This symbol indicates that there are important operating and maintenance instructions in the literature accompanying this unit.



This symbol indicates that dangerous voltage constituting a risk of electric shock is present within this unit.

**Warning:** The AC Input connector (see page 8) is used as a safety disconnect device. It must be easily accessible after installation.



This equipment is a Class II or double insulated electrical appliance. It has been designed in such a way that it does not require a safety connection to electrical earth.



**Correct disposal of this product:**

This marking indicates that this product should not be disposed of with other household wastes throughout the EU. To prevent possible harm to the environment or human health from uncontrolled waste disposal, recycle it responsibly to promote the sustainable reuse of material resources. To return your used device, please use the return and collection systems or contact the retailer where the product was purchased. They can take this product for environmentally safe recycling.

**Read and keep these instructions.  
Heed all warnings and follow all instructions.**

Do not use this apparatus near water.  
Clean only with a dry soft cloth.  
Do not block any ventilation openings.  
Install in accordance with the manufacturer's instructions.

**Warnings:**

To avoid the danger of suffocation, keep all polythene bags and packaging away from babies and children.

To reduce the risk of fire or electrical shock, do not expose this product to rain or moisture. This product must not be exposed to dripping and splashing and no object filled with liquids such as a vase of flowers should be placed on the unit.

Do not install near any heat sources such as radiators, heat registers, stoves, or other apparatus (including amplifiers) that produce heat.

Do not defeat the safety purpose of the polarized or grounding type plug. A polarized plug has two blades with one wider than the other. A grounding type plug has two blades and a third grounding prong. The wider blade or the third prong are provided for your safety. If the provided plug does not fit into your outlet, consult an electrician for replacement of the obsolete outlet.

Take note of all warnings on the appliance, under no circumstances disassemble the unit or remove covers to prevent the risk of fire or electrical shock.

Protect the mains power cord from being walked on or pinched, particularly at plugs, convenience receptacles, and the point where they exit from the apparatus.

Use only attachments/accessories specified by the manufacturer.

Unplug this unit during lightning storms or when unused for long periods of time.

No naked flame sources such as candles should be placed on the product.

**Caution:**

Changes or modifications not expressly approved by the manufacturer could void the user's authority to operate this device.

Third parties: In the unlikely event that you pass this product on to a third party, include these operating instructions with the product.

**Service:**

Refer all servicing to qualified service personnel. Servicing is required when the unit has been damaged in any way, such as the power supply cord or plug is damaged, liquid has been spilled on or objects have fallen into the unit, the apparatus has been exposed to rain or moisture, it does not operate normally or it has been dropped.

Equipment for servicing should be returned to the supplying dealer, or to the service agent for your area. The address of the main Service Agent for the UK is listed at the back of this manual.

**Important notice for UK users:**

The UK mains lead is terminated with a UK approved mains plug fitted with a 3A fuse. If the fuse needs to be replaced, an ASTA or BSI approved BS1362 fuse rated at 3A must be used.

## Introduction

**Thank you for purchasing Q Acoustics.**

This manual is intended to take you through the setup and installation of the unit and will help provide a trouble free setup and optimum performance from the product.

Please read the instructions, important safety information and warnings carefully before installation and use, to ensure the safe and satisfactory operation of this product.

We hope you enjoy the Q Acoustics experience.

## Package Contents

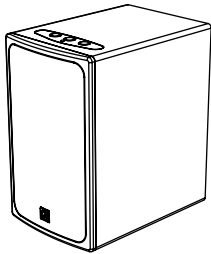

1 x Active Right Speaker

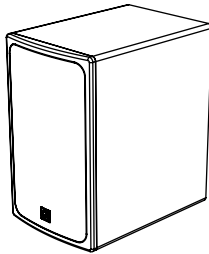

1 x Passive Left Speaker

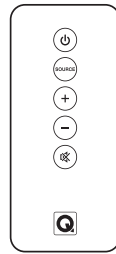

1 x Remote Control



1 x Lithium Battery (3V, CR2025)



1 x RCA Phono Lead (2 metres)



1 x 3.5mm Jack Lead (2 metres)



1 x Two Pole Speaker Cable (4 metres)

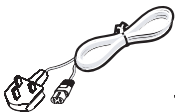

1 x UK AC Mains Cable



1 x EU AC Mains Cable



1 x AS/NZS AC Mains Cable

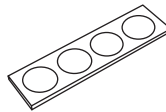

2 x Sets of Rubber Bumpers



1 x User Manual

# Features

---



## Feature Summary

- 2 x 50W stereo amplifier in right hand speaker
- Passive left hand speaker
- 1 x 100mm woofer and 1 x 30mm dome tweeter per speaker
- aptX® *Bluetooth* input – up to 8 paired devices
- Digital optical audio input
- RCA stereo line level audio input
- 3.5mm stereo headphone level audio input
- RCA subwoofer line level audio output
- 5 button infrared remote control



## Product Description

The Q Acoustics Q-BT3 is a bookshelf Bluetooth stereo speaker set designed to deliver high fidelity reproduction of music, and high quality audio from a TV or set top box. This unit has been designed in the UK by Q Acoustics and is a result of careful development and our award winning heritage.

Q Acoustics provides true audio with no added effects or digital signal processing to colour audio reproduction. You have peace of mind that you are listening to pure audio as the original mix engineer intended.

The left and right speakers each have our award winning combination of 100mm woofer and 30mm dome tweeter, providing focused channel separation, music depth and clarity, voiced by our acoustic team to provide a full range natural sound.

Designed for simplicity, this product will blend into your home environment with minimal fuss yet extraordinary improvement to your listening experience.

With both analogue and optical inputs, the unit can be used with a variety of entertainment sources such as TVs, CD players, portable music players, computers and internet radio.

The unit is also Bluetooth compatible using aptX Lossless for audio streaming. This wireless connection can sync to almost any Bluetooth compatible audio device. It can remember up to eight pairings, so when friends or family come over, a 'guest' music player can get connected in just seconds.

Please read and follow the instructions in this manual to get the most enjoyment out of your purchase.

Attaching the Feet

1.

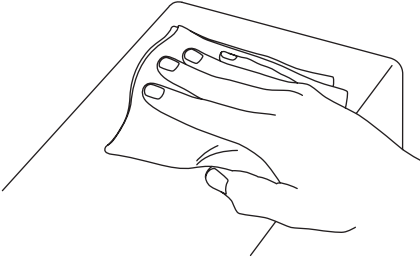

2.

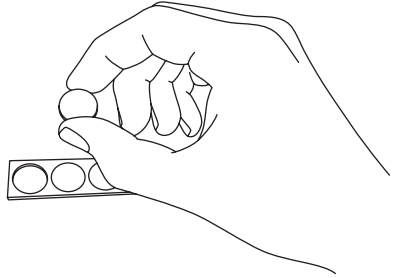

3.

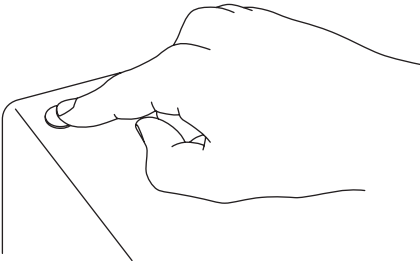

4.

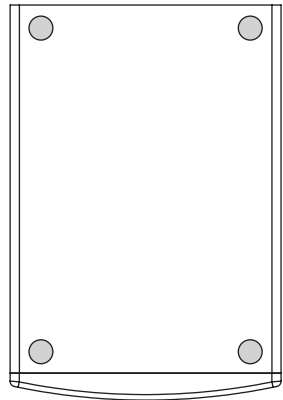

# Instructions

## Q-BT3 Features

### TOP PANEL

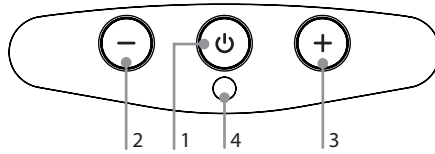

#### 1. Standby / Source Select

Long press / short press

#### 2. Volume Down

Single press / press and hold

#### 3. Volume Up

Single press / press and hold

#### 4. Status LED

See LED indications below

#### No Light = Off

Power cord is connected but AC switch is turned OFF, or power cord is disconnected.

#### Solid Red = Off (Standby)

Power cord is connected and AC switch is turned ON, but the unit is OFF.

#### Solid Green = On

Analogue input (Line in 1 or Line in 2) is the active source.

#### Solid White = On

Optical input is the active source.

#### Quick Blue Flash = On

Bluetooth input is the active source and is currently searching for a Bluetooth device to PAIR with.

#### Solid Blue = On

Bluetooth input is the active source and is PAIRED with a Bluetooth device.

#### Any Colour Slow Flash = On

Currently active source is MUTED.

### FRONT VIEW

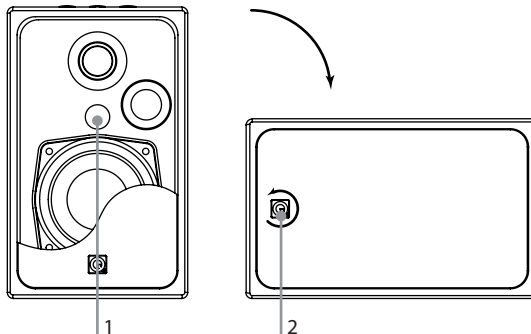

#### 1. IR Sensor

The IR sensor is hidden behind the speaker grill of the active right speaker. It sees the IR control commands output from the unit IR remote control when buttons are pressed.

*This sensor MUST be unobstructed for direct line-of-sight to the remote, or the remote will not be able to control the unit.*

#### 2. Rotating Badge

The speakers are designed to be used in both vertical and horizontal orientations to suit your preferred setup.

*When using this product in the horizontal orientation, you may rotate the Q Acoustics logo by gently pulling and rotating the badge.*



REAR PANEL

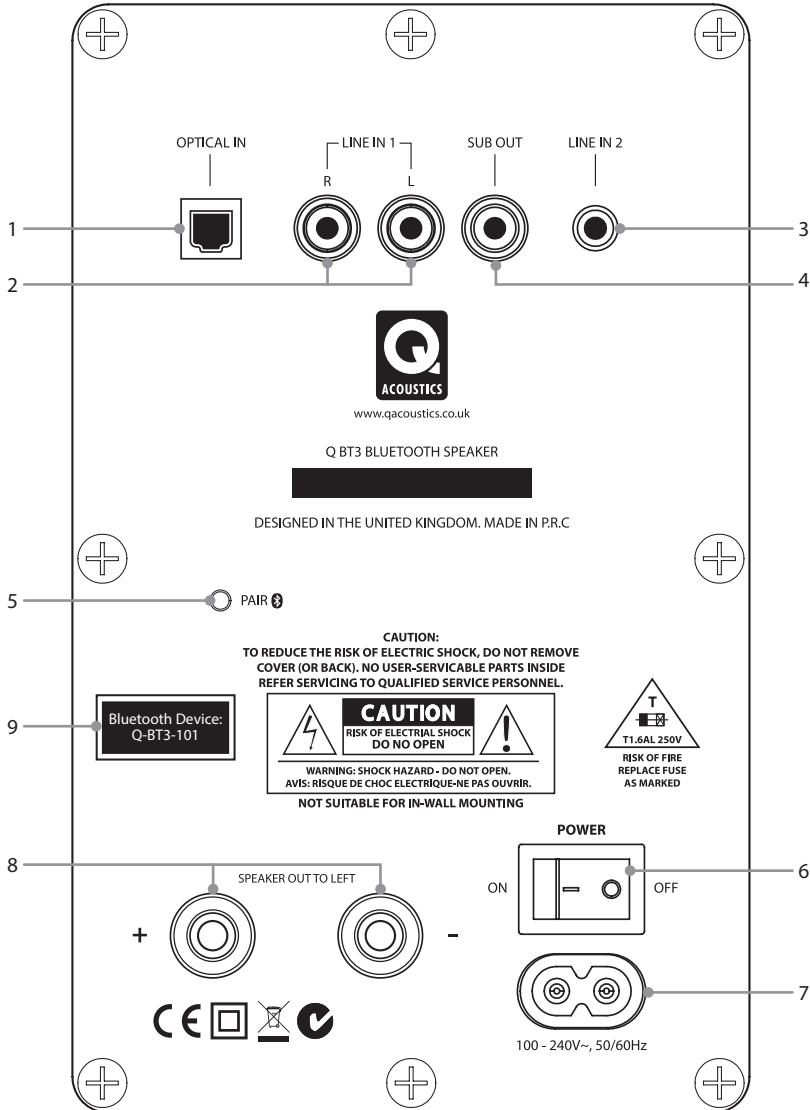

- 1. Digital Optical Input
- 2. Analogue Line In 1
- 3. Analogue Line In 2
- 4. Subwoofer Out
- 5. Bluetooth Pair Button

- 6. Power Switch
- 7. AC Input
- 8. Output Speaker Terminals
- 9. Bluetooth Name Label

# Instructions

## 1. Digital Optical Input

TOSLINK connector for connection to the Digital Optical output on a TV or other source. If there is a choice between Digital or Analogue connection to the unit choose Digital for superior audio quality. The Digital input is selected automatically if no Bluetooth device is connected and playing. When the Digital Source is active the status LED will be WHITE.

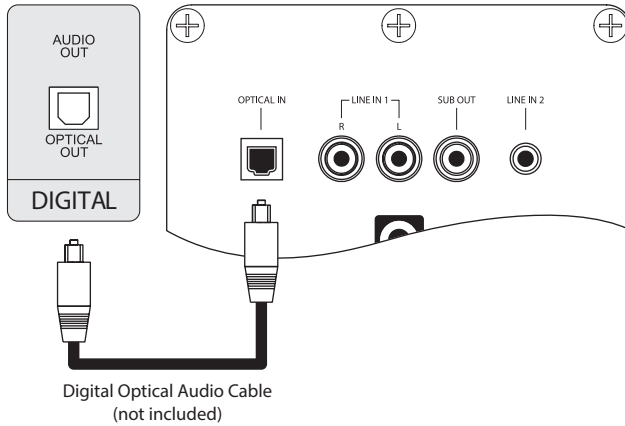

### Important Note:

Audio output of a TV, Blu-ray disc player, games console, or DVD player connected to the unit via Optical Digital, must be set to PCM (two channel stereo) in the source's setup. Please see the device's Owner's Manual for details. Digital connection to a CD player does not require a special setting.

## 2 & 3. Analogue Inputs Line In 1 & Line In 2

The unit has two options for Analogue Audio connection:

### Line In 1

Connect the RCA L&R audio output from a TV or other source to the LINE IN 1 sockets using the 2m cable provided:

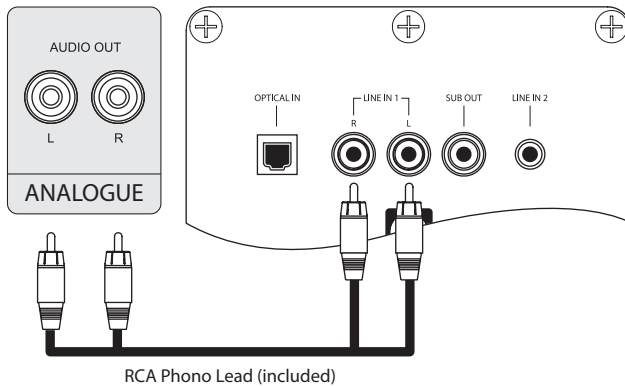

## Line In 2

The 3.5mm input jack is ideal for connecting to the headphone output of an external audio source using the 2m cable provided:

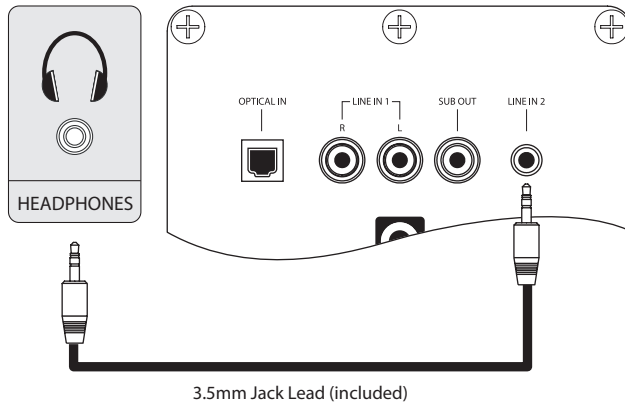

### Important Note:

With a jack plugged into LINE IN 2, LINE IN 1 is switched-off and no audio will be heard from this source.

The ANALOGUE INPUTS are automatically selected when no *Bluetooth* device is connected and playing, and no Optical Digital Input signal is present. The Status LED will be GREEN when an analogue input is in use.

### Please Note:

When connecting to a variable level source, such as a headphone output, better audio quality will be achieved by having the source set at a higher volume level and the unit at a lower level than the other way around.

## 4. Subwoofer Out

Single RCA phono jack. Connect the 'Sub Out' to a Subwoofer Line Level Input if extended bass response is desired.

## 5. Bluetooth Pair Button

The unit has been designed to automatically search for, and PAIR with a device should no other devices currently be PAIRED and in range. This *Bluetooth* Pair button is used to manually drop the current connection and pair with a new device.

## 6. Power Switch

Turns the power to the unit ON/OFF.

### Important Note:

Always turn the power OFF when making connections to the Rear Panel.

## 7. AC Input

Universal power connector. Automatically selects AC voltage for a given region. Connect to the included AV Power Cord for your country.

# Instructions

## Remote Control

### 1. Power

Press this button to turn the unit Standby ON/OFF. (POWER SWITCH on the rear panel must be switched to ON)

### 2. Source Select

Press this button to manually select the audio input source. The status LED will change colour accordingly.

#### Important Note:

When the Source button is used, the unit will stay on the selected source and stop auto-source selection. Auto-source selection will be resumed after the unit has been put in standby.

### 3. Volume Up / Down

Press VOL + to increase the volume. Press VOL - to reduce the volume.

### 4. Mute

Press this button once to MUTE the unit (no audio output from the speakers). Status LED will SLOW FLASH to indicate MUTE. Press this button again to un-mute the unit (audio output from the speakers).

#### Please Note:

Long press of Mute will also put the unit into standby.

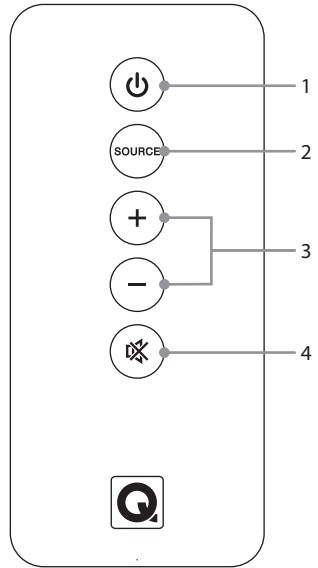

## REMOTE CONTROL BATTERY REPLACEMENT

#### Caution:

When replacing the lithium battery in the remote, make sure that the replacement battery is inserted in correct polarity. Place the battery so that its positive (+) side faces up with the tray held so the surface with the dot and (+) is facing up.

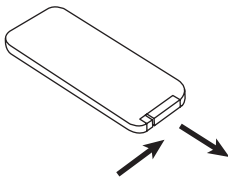

1. Push small tab toward battery slot.

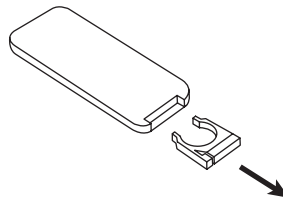

2. Pull battery drawer out.

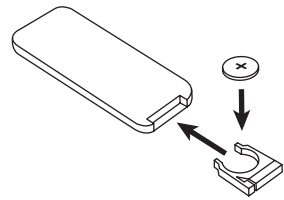

3. Insert battery with "+" side up and slide drawer back into remote.

#### Caution:

Danger of explosion if battery is incorrectly replaced. Replace only with the same or equivalent battery type (CR2025)

#### Warning:

Do not expose batteries to excessive heat such as direct sunlight, fire or the like. Dispose of dead batteries in accordance with local regulations.



## Operating Q-BT3

### POWER AND STANDBY

Power on the unit at the AC SWITCH once all rear panel audio connections are made. The speakers will enter STANDBY, with a RED status LED.

Exit STANDBY by pressing the STANDBY button on either the top panel or the IR remote. The LED will initially turn Green but may then change according to the Auto-Source Selection rules.

If NO input signals are detected, the unit will automatically enter STANDBY after 20 minutes.

### AUTO-SOURCE SELECTION

In normal operation the unit will automatically select the audio source. A Connected *Bluetooth* source that starts to play has the highest priority, followed by Digital and finally Analogue:

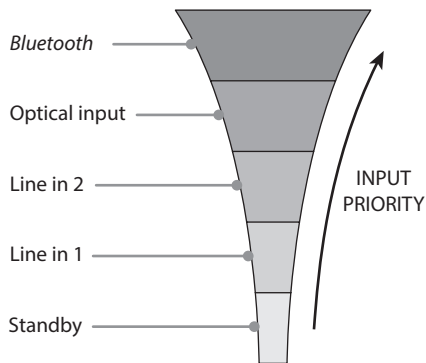

The Auto-Source Selection can be manually overridden at any time using SOURCE SELECT on the IR remote or by a short press of the  button on the unit.

#### Important Note:

The unit will stop using Auto-Source Selection when the source is manually selected using the Source Select button on the remote, or a short press of the Standby Button on the unit. Auto-Source Select will resume once the unit has been put into and out of Standby.

# Instructions

---

## SOURCE VOLUME CONTROL

Audio sources will initially be set at a DEFAULT volume level. The volume can be adjusted separately for each source using the VOL + and VOL – buttons on the top panel or IR remote. Once adjusted, the unit will remember the new volume level for the currently selected source, and will return to that level each time that source is re-selected.

## PAIRING A BLUETOOTH DEVICE

The unit is designed to automatically go into pairing mode if there is no *Bluetooth* device connected. To Pair your *Bluetooth* source:

1. Turn the unit and the *Bluetooth* device ON.
2. Make sure *Bluetooth* is enabled on the device to be Paired. The *Bluetooth* controls are typically found in the device's 'Settings' or 'Connections' menu.
3. On your device's list of discoverable devices, you should now see 'Q-BT3-XXX' where XXX is a pre-defined three digit number. (*Refer to Rear Panel section for the Bluetooth name label.*)
4. Select 'Q-BT3-XXX' and your device will now be Paired via *Bluetooth* and Connected.
5. From within the music player on your device, select 'Q-BT3-XXX' as the audio output and press Play. Unless the remote has been used to manually select another source and override Auto-Source Selection, the unit will switch to *Bluetooth* input and the LED will turn Blue.

### **Please Note:**

Although starting to Play a track on the connected source will cause the unit to switch to *Bluetooth*, the unit will stay on *Bluetooth* until the source is disconnected. It will not switch to another source whilst the player is paused.

### **Please Note:**

Auto-Source Selection will switch to *Bluetooth* the first time a connected device sends any audio signal including message received alerts and key press effects.

### **Please Note:**

When connected, the device's volume and mute controls control the device itself, not the unit. Better audio quality will be achieved by having the device set at a higher volume level and the unit at a lower level.

## **GOING OUT OF RANGE**

When a connected device goes out of range, the unit will remain on the Bluetooth channel. When the device returns in range it will automatically re-connect to the unit. In many cases PLAY must be pressed on the device to resume audio playback. Whilst out of range, source can still be changed using the SOURCE SELECT button.

**Please Note:**

If the source does not come back into range for 20 minutes the unit will automatically go into standby.

## **PAIRING MORE THAN ONE *BLUETOOTH* DEVICE**

The unit can have up to eight Bluetooth devices in its pairing list. When you pair with the 9th device the details of the first device will be lost.

Once the unit is connected with a device, it will stop automatically searching for other devices to pair with or connect to. To connect to another device, either disconnect the currently connected source on the device itself or press the *Bluetooth* Pair button on the rear panel of the unit.

## **COMING OUT OF STANDBY**

If there is a paired device in proximity to the unit when it comes out of standby it will automatically initiate a connection to the device. It will not switch to *Bluetooth* input until play is pressed on the device.

# Instructions

## CABLE/SATELLITE REMOTE CONTROL

The Q Acoustics system has been designed for easy integration into your home entertainment system as it has the ability to be controlled by many types of PROGRAMMABLE REMOTE CONTROL. This may include the remote control for your SATELLITE and CABLE system if it has PUNCH THROUGH capability. Punch through is the common term for being able to programme your remote control to send IR codes to both a TV and an AV Preamplifier/Processor. To use punch through you normally select the TV you wish to support first, and then the AV Preamplifier/Processor.

The unit uses the PHILIPS RC5 protocol for AV Preamplifiers/Processors. Programming your remote with PHILIPS AV codes should allow you to control volume and mute of your unit. In some cases you may also be able to control standby and source select with buttons such as ◀▶ ▶▶ ◀ and ▶▶▶▶.

Manufacturers often offer several PHILIPS code options for their remote controls. We recommend that you work through the PHILIPS code list for your remote and experiment with each one until you find one that works well with the unit. It is easiest to recognise when one is working by pressing the volume up/down buttons.

We cannot guarantee that the unit will work with your particular remote as the IR codes it sends are outside our control, however by supporting the commonly used Philips standard we hope to have made it as easy as possible to gain control of your device with the remote control of your choice.

Below we show how two typical programmable remote controls can be set up.

### TYPE 1 (SATELLITE)

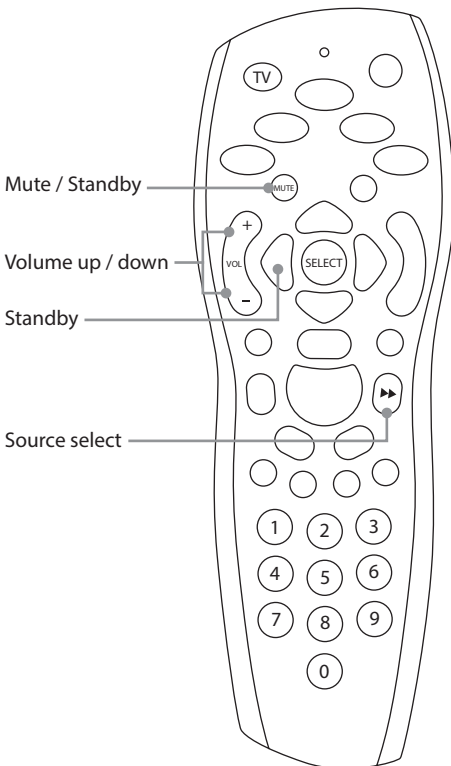

- Press the "TV" button (top left of remote).
- Point remote away from receiver, press and hold "Select + 0".
- The remote's LED will flash red twice.
- Enter "1217". The remote's LED will flash red twice to confirm correct code.
- Press and hold "Select + 1".
- The remote's LED will flash red twice.
- Press TV and your remote controls will now work as below:

Button	Function
Vol +	Volume up
Vol -	Volume down
Mute (short press)	Mute
◀ or Mute (long press)	Standby
▶▶	Source select



## TYPE 2 (CABLE)

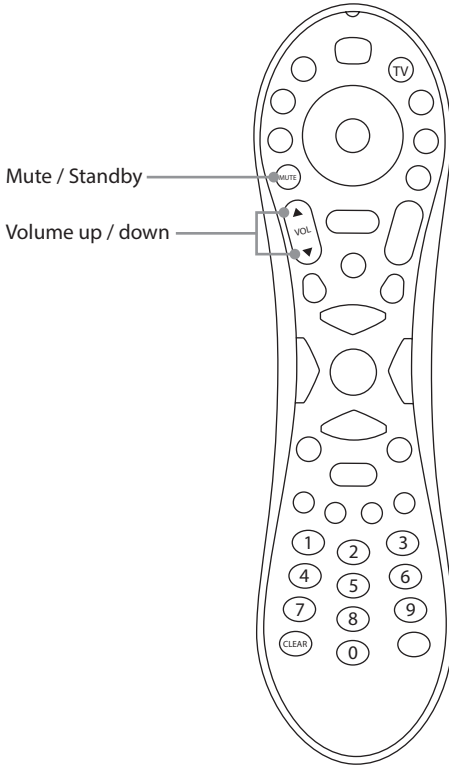

- Press the “TV” button (top right of remote).
- Point remote away from receiver, press and hold “Clear + Vol ▲”.
- The remote’s LED will flash green twice.
- Enter “1247”. The remote’s LED will flash green twice to confirm correct code.
- Press TV and your remote controls will now work as below:

Button	Function
Vol ▲	Volume up
Vol ▼	Volume down
Mute (short press)	Mute
Mute (long press)	Standby

# Specification



## Specification

### Audio performance

Power output:	2 x 50W for 100W total amplification
THD (at rated power):	<1.00%
Frequency response:	±0.5dB 20Hz to 20kHz
S/N ratio (A-Wtd):	-85dB
Line in 1 (RCA phono) input sensitivity:	2.0Vrms
Line in 1 (RCA phono) input overload:	2.2Vrms
Line in 2 (3.5mm jack) input sensitivity:	1.0Vrms
Line in 2 (3.5mm jack) input overload:	1.2Vrms

### Speakers

Enclosure type:	2-way reflex
Mid range driver:	100mm
Tweeter:	30mm

### Power consumption

Standby:	<0.5 Watts
No signal (idle):	14 Watts
Rear panel marked line ratings:	100~240V - 50~60Hz 100W

### Bluetooth®

Bluetooth specification:	V4.0 class 2 device
Latency:	6ms
Internal stereo CODEC:	16-bit
Stereo audio sample rate:	up to 48kHz
Music enhancements:	aptX®, SBC, MP3
Support for:	A2DP, 802.11 co-existence

### Dimensions

(W x H x D):	148mm x 240mm x 208mm
Depth including terminals:	226mm

### Weight

Active right speaker:	3.8kg
Passive left speaker:	3.4kg
Total weight:	7.2kg



## Q Acoustics Warranty

Q Acoustics products are warranted free of defects in materials and workmanship for a period of 2 years from the date of purchase. During the warranty period Q Acoustics will, at its option, repair or replace any product found to be faulty after inspection by the company or its appointed distributor or agent.

Misuse and fair wear and tear are not covered by warranty.

Goods for repair should in the first instance be returned to the supplying dealer. If this is not possible contact Q Acoustics or their appointed distributor for your area to determine the correct warranty procedure. If possible the original packaging should be used to return the product as damage sustained during transit to the repair centre is not covered by the warranty. The warranty does not in any way affect your legal rights.

### **Q ACOUSTICS**

Armour Home Electronics Ltd.  
Stortford Hall Industrial Park  
Bishops Stortford, Herts, UK  
CM23 5GZ



The *Bluetooth* word mark and logos are registered trademarks owned by Bluetooth SIG, Inc. and any use of such marks by Armour Home Electronics Ltd. is under license. The aptX® mark and the aptX logo are trade marks of CSR plc or one of its group companies and may be registered in one or more jurisdictions. Other trademarks and trade names are those of their respective owners.



[www.Qacoustics.co.uk](http://www.Qacoustics.co.uk)